



# IMM.M.M.

# H.H.H.

Adattatori miscellanea / miscellaneous Adaptors

H

# IMHy press

IMM Group



## Adattatori Miscellanea

Pagina / Page		2		2		3		3	
<b>Metric nipples</b>			<b>BSPT BSPT</b>		<b>NPTF NPTF</b>				
	<b>1750</b> Union	<b>1770</b> Reducing Connector		<b>1860</b> Union		<b>1870</b> Union			
Pagina / Page		4		4		6		6	
<b>Metric plugs</b>			<b>Metric Banjos</b>						
	<b>M608</b> Metric Female Plug Swivel	<b>M605</b> Male Plug M Metric		<b>1500</b> Weldable Banjo Eye Metric - Metric Socket		<b>1570</b> Threaded Banjo Eye Metric - Metric			
Pagina / Page		7		7		5			
<b>BSP Bolt</b>			<b>Metric Bolt</b>						
	<b>1600-00</b> BSP Perfored Bolt	<b>1600</b> BSP Perfored Bolt (Double)		<b>1650</b> Metric Perfored Bolt					
Pagina / Page		9		8		8		9	
<b>BSP Metric Banjos</b>			<b>BSP Banjos</b>						
	<b>1550</b> Threaded Banjo Eye BSP - Metric		<b>1450</b> Weldable Banjo Eye BSP - Metric Socket	<b>1550</b> Threaded Banjo Eye BSP - BSP	<b>1580</b> Threaded Banjo Eye BSP - DIN 24°				
Pagina / Page		10		11		12		13-20	
<b>Rondelle Bonded</b>				<b>Seal</b>					
	<b>RG00 - RM00</b> Copper washer BSP - Metric	<b>RB00 - RBM0</b> Bondend Seal BSP - Metric	<b>RBMA - RBGA</b> Self-cent. Bonded Seal BSP - Metric						Seals for adaptors and fittings
Pagina / Page		21		21		22			
<b>Box O-Ring</b>			<b>Bonded seals kit</b>						
	<b>BOXG-BS-70</b> O-ring NBR 70 shore British standard	<b>BOXH-MS-70</b> O-ring NBR 70 shore Metric standard		<b>BOXBG</b> Kit bonded autocentranti - BSP BSP - Self-centering bonded seal kit					

Dimensions and general characteristics may be changed at any time without prior notice.

Data contained herein are for information purpose only, and it does not enlarge, amend or imply any warranty other than provided by us with the product  
Any use of the product not in conformance with our instructions may be dangerous.

## 1750 **Nipplo di giunzione metrico cono 60°**

Metric male connector 60° cone

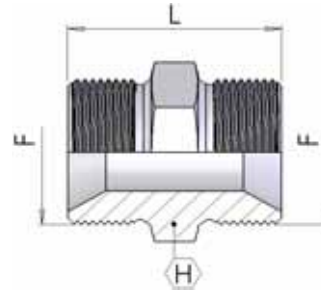

part number	Dimensions		
	F	L	H
1750-10-10	M10 x 1	21	14
1750-12-12	M12 x 1.5	29	17
1750-14-14	M14 x 1.5	31	19
1750-16-16	M16 x 1.5	34	22
1750-18-18	M18 x 1.5	37	24
1750-20-20	M20 x 1.5	36	27
1750-22-22	M22 x 1.5	36	27
1750-24-24	M24 x 1.5	36	30
1750-26-26	M26 x 1.5	40	32
1750-30-30	M30 x 1.5	43	36

## 1770 **Nipplo di riduzione metrico cono 60°**

Reducing Metric Niple 60° come

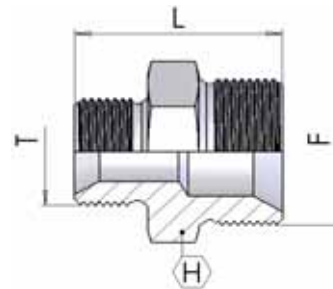

part number	Dimensions			
	F	T	L	H
1770-14-12	M14 x 1.5	M12 x 1.5	27	19
1770-16-12	M16 x 1.5	M12 x 1.5	31	22
1770-16-14	M16 x 1.5	M14 x 1.5	33	22
1770-18-14	M18 x 1.5	M14 x 1.5	34	24
1770-18-16	M18 x 1.5	M16 x 1.5	30	24
1770-22-14	M22 x 1.5	M14 x 1.5	34	27
1770-22-18	M22 x 1.5	M18 x 1.5	34	27
1770-26-22	M26 x 1.5	M22 x 1.5	38	32

## 1860 **Nipplo di giunzione gas conico**

BSPT male x BSPT male connector

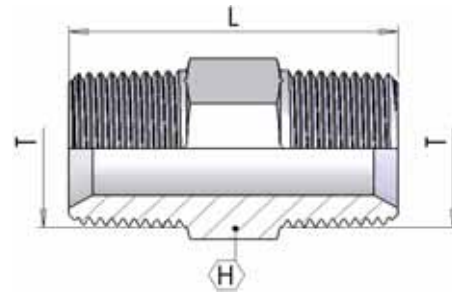

part number	Dimensions		
	T	L	H
1860-02-02	1/8-28	26	12
1860-04-04	1/4-19	35	15
1860-06-06	3/8-19	37	19
1860-08-08	1/2-14	46	22
1860-12-12	3/4-14	53	27
1860-16-16	1-11	60	36
1860-20-20	1.1/4-11	68	46
1860-24-24	1.1/2-11	71	50
1860-32-32	2-11	74	65

## 1870 **Nipplo di giunzione NPTF**

NPTF male x NPTF male connector

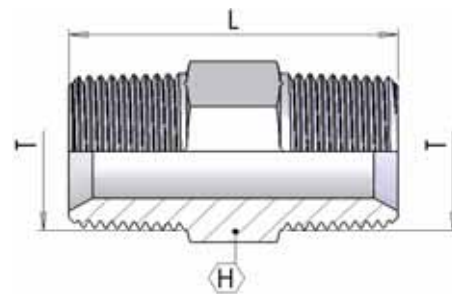

part number	Dimensions		
	T	L	H
1870-04-04	1/4-18	35	15
1870-06-06	3/8-18	37	19
1870-08-08	1/2-14	48	22
1870-12-12	3/4-14	53	27
1870-16-16	1-11.1/2	63	36
1870-20-20	1.1/4-11.1/2	68	46
1870-24-24	1.1/2-11.1/2	71	50
1870-32-32	2-11.1/2	74	65

## M608 Tappo femmina girevole metrico

Metric 60° swivel female plug

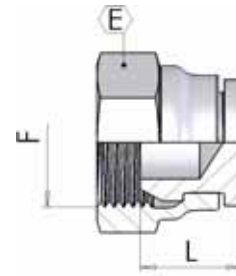

part number	Dimensions		
	F	L	E
M608-14	M14 x 1.5	12	19
M608-16	M16 x 1.5	15	22
M608-18	M18 x 1.5	15	24
M608-22	M22 x 1.5	18	27
M608-26	M26 x 1.5	20	32

## M605 Tappo Metrico

Male Plug

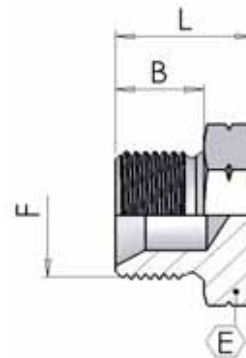

part number	Dimensions			
	F	B	L	E
M605-10	M10x1	8	13	14
M605-12	M12x1,5	12	19	17
M605-14	M14x1,5	12	19	19
M605-16	M16x1,5	12	19	22
M605-18	M18x1,5	12	20	24
M605-20	M20x1,5	14	22	27
M605-22	M22x1,5	14	22	27
M605-24	M24x1,5	14	22	30
M605-26	M26x1,5	16	24	32

**1650 Bullone forato metrico**

Metric perfored bolt

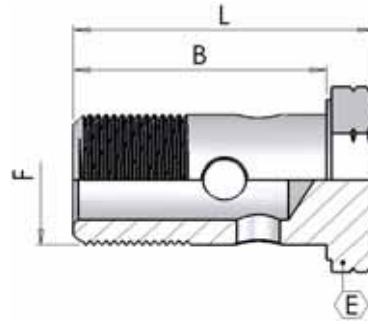

part number	Dimensions			
	F	B	L	E
1650-00-10	M10 x 1	19	24	14
1650-00-12	M12 x 1.5	26	31	17
1650-00-14	M14 x 1.5	29	34	19
1650-00-16	M16 x 1.5	33	41	22
1650-00-18	M18 x 1.5	37	44	24
1650-00-20	M20 x 1.5	38	46	27
1650-00-22	M22 x 1.5	38	46	27
1650-00-26	M26 x 1.5	47	56	32
1650-00-30	M30 x 1.5	58	68	36

## 1500 Occhio metrico a saldare

Weldable Metric Banjo Eye

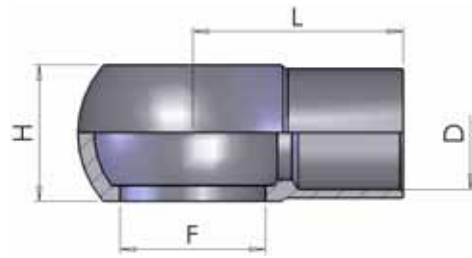

trattamento superficiale: non zincato  
 surface treatment: without zinc plating

part number	Dimensions			
	F	D	L	H
1500-08-05	M8x1	5	15	8
1500-10-06	M10x1	6	17	10
1500-12-08	M12x1,5	8	22	12
1500-14-08	M14x1.5	8	24	14
1500-14-10	M14 x 1.5	10	24	14
1500-16-10	M16x1.5	10	28	18
1500-16-12	M16 x 1.5	12	28	16
1500-18-12	M18 x 1.5	12	29	20
1500-18-14	M18x1.5	14	29	20
1500-18-15	M18 x 1.5	15	29	20
1500-20-12	M20x1.5	12	32	22
1500-20-14	M20x1.5	14	32	22
1500-22-16	M22 x 1.5	16	32	30
1500-22-18	M22x1.5	18	32	22
1500-26-20	M26 x 1.5	20	41	28
1500-26-22	M26x1.5	22	40	29

## 1570 Occhio filettato metrico

Metric threaded Banjo Eye

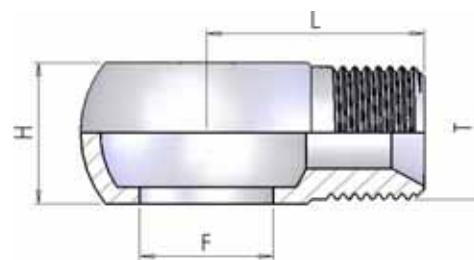

part number	Dimensions			
	F	T	L	H
1570-14-14	M14 x 1.5	M14 x 1.5	24	14
1570-18-18	M18 x 1.5	M18 x 1.5	30	20
1570-22-22	M22 x 1.5	M22 x 1.5	36	22



**1600-00 Bullone forato Gas**

BSP perfored bolt

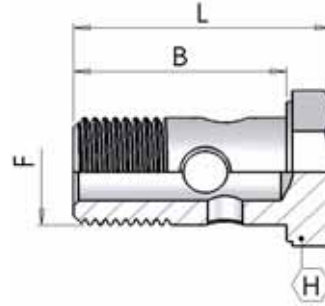

part number	Dimensions			
	F	B	L	H
1600-00-02	1/8"-28	19	24	14
1600-00-04	1/4"-19	29	34	19
1600-00-06	3/8"-19	33	41	22
1600-00-08	1/2"-14	38	46	27
1600-00-10	5/8"-14	44	54	30
1600-00-12	3/4"-14	47	56	32
1600-00-16	1"-11	58	69	38

**1600 Bullone forato doppio Gas**

BSP double perfored bolt

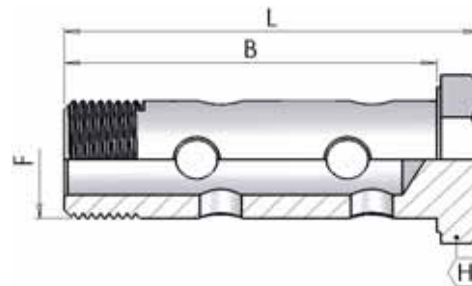

part number	Dimensions			
	F	B	L	H
1600-04-04	1/4"-19	43	49	19
1600-06-06	3/8"-19	49	57	22
1600-08-08	1/2"-14	62	70	27
1600-12-12	3/4"-14	78	87	32
1600-16-16	1"-11	98	109	41

## 1550 Occhio filettato Gas

BSP threaded Banjo Eye

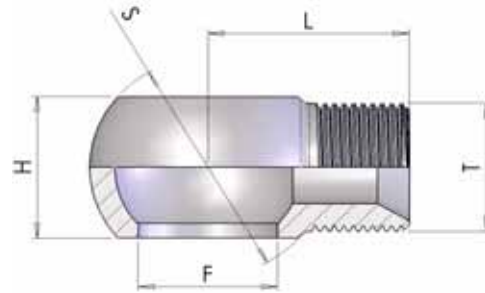

part number	Dimensions				
	F	T	L	H	S
1550-04-04	1/4	1/4-19	24	14,5	24
1550-06-04	3/8	1/4-19	26	17,0	28
1550-06-06	3/8	3/8-19	28	17,0	28
1550-06-08	3/8	1/2-14	28	22,0	28
1550-08-06	1/2	3/8-19	30	22,0	36
1550-08-08	1/2	1/2-14	32	22,0	36
1550-12-08	3/4	1/2-14	47	29,0	45
1550-12-12	3/4	3/4-11	38	29,0	45
1550-16-12	1	3/4-11	45	28,0	58
1550-16-16	1	1-11.5	51	38,0	58

## 1450 Occhio a saldare Gas

Weldable BSP Banjo Eye

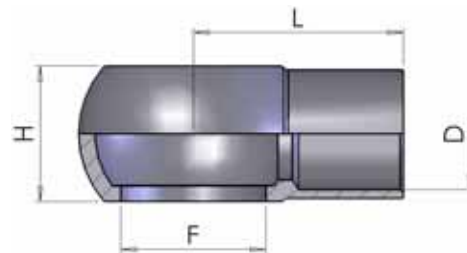

trattamento superficiale: non zincato  
 surface treatment: without zinc plating

part number	Dimensions			
	F	D	L	H
1450-04-06	1/4-13.5	6	23	15,0
1450-04-08	1/4-13.5	8	23	15,0
1450-04-10	1/4-13.5	10	23	15,0
1450-04-12	1/4-13.5	10	24	15,0
1450-06-10	3/8-16.7	10	28	17,0
1450-06-12	3/8-16.7	12	28	17,0
1450-08-15	1/2-21	15	32	22,0
1450-08-16	1/2-21	16	32	22,0
1450-12-20	3/4-26.5	20	41	29,0
1450-12-22	3/4-26.5	22	40	29,0
1450-16-27	1-33.3	27	50	38,0

### 1550 Occhio filettato

Threaded Banjo Eye

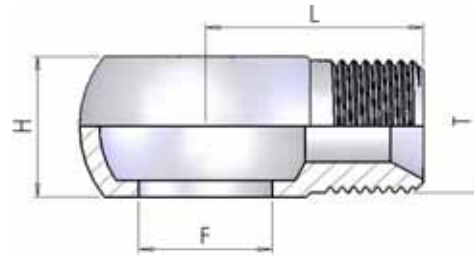

part number	Dimensions			
	F	T	L	H
1550-04-14	1/4	M14 x 1.5	24	14
1550-06-18	3/8	M18 x 1.5	26	18

### 1580 Occhio filettato cono 24°

Threaded Banjo Eye 24° cone

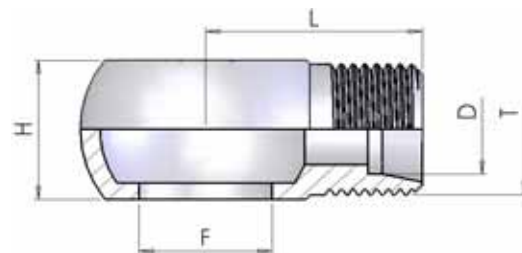

part number	Dimensions				
	F	T	D	L	H
1580-06-18	3/8	M18 x 1.5	12	26	17
1580-06-22	3/8	M22 x 1.5	15	38	17
1580-08-18	1/2	M18 x 1.5	12	38	22
1580-08-22	1/2	M22 x 1.5	15	38	22

**RM00 Rondella di Rame Metrica**

Metric copper washer

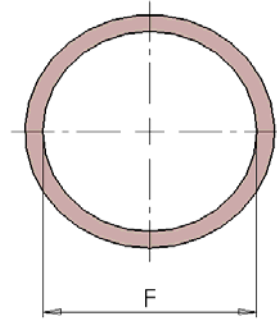

part number	Dimensions		
	F		
RM00-06	M6		
RM00-08	M8		
RM00-10	M10		
RM00-12	M12		
RM00-14	M14		
RM00-16	M16		
RM00-18	M18		
RM00-20	M20		
RM00-20-26	M20		
RM00-22	M22		
RM00-26	M26		
RM00-28-34	M28		
RM00-30	M30		

**RG00 Rondella di Rame BSP**

BSP copper washer

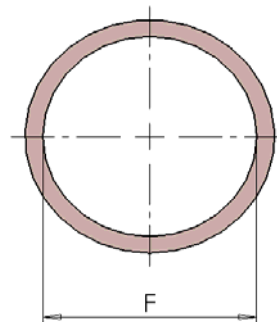

part number	Dimensions		
	F		
RG00-02	G 1/8"		
RG00-04	G 1/4"		
RG00-06	G 3/8"		
RG00-08	G 1/2"		
RG00-10	G 5/8"		
RG00-12	G 3/4"		
RG00-16	G 1"		
RG00-20	G 1.1/4"		
RG00-24	G 1.1/2"		
RG00-32	G 2"		

## RBM0 Rondella Metric Bonded

Metric Bonded Seal

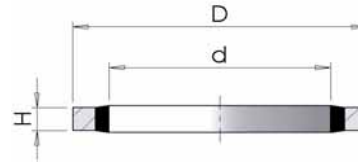

part number	Dimensions			
	F	d	D	H
<b>RBM0-05</b>	M5		8,4	1,2
<b>RBM0-06</b>	M6		13,2	1,2
<b>RBM0-08</b>	M8		14,2	1,2
<b>RBM0-10</b>	M10		18,4	2,0
<b>RBM0-14</b>	M14		22,2	2,0
<b>RBM0-16</b>	M16		25,4	2,0
<b>RBM0-18</b>	M18		26,9	2,3

## RB00 Rondella BSP Bonded

BSP Bonded Seal

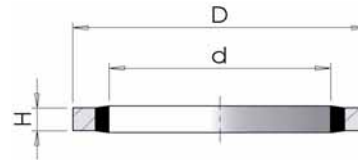

part number	Dimensions			
	F	d	D	H
<b>RB00-02</b>	G 1/8"		14,0	2,0
<b>RB00-04</b>	G 1/4"		20,6	2,0
<b>RB00-06</b>	G 3/8"		23,9	2,0
<b>RB00-08</b>	G 1/2"		28,7	2,0
<b>RB00-10</b>	G 5/8"		31,8	2,0
<b>RB00-12</b>	G 3/4"		35,0	2,0
<b>RB00-16</b>	G 1"		42,9	2,5
<b>RB00-20</b>	G 1.1/4"		52,5	2,5
<b>RB00-24</b>	G 1.1/2"		58,7	3,2
<b>RB00-32</b>	G 2"		73,0	2,5

## RBMA **Bonded Autocentranti Metrici**

Metric Self-centering Bonded Seal

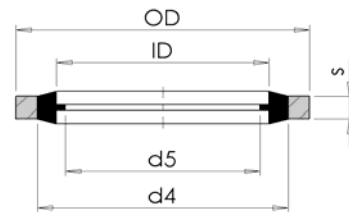

part number	Dimension					Thread
	ID	OD	d4	d5	s	
RBMA-04	4,50	7,00	5,40	3,30	1,00	M4
RBMA-08	8,70	14,00	10,40	6,40	1,00	M8
RBMA-10	10,70	16,00	12,40	8,05	1,50	M10
RBMA-12	12,70	18,00	14,40	10,20	1,50	M12
RBMA-14	14,70	22,00	16,40	11,38	1,50	M14
RBMA-16	16,70	24,00	18,40	13,41	1,50	M16
RBMA-18	18,70	26,00	20,40	14,76	1,50	M18
RBMA-20	20,70	28,00	22,50	16,76	1,50	M20
RBMA-22	22,70	30,00	24,40	18,74	2,00	M22

## RBGA **Bonded Autocentranti BSP**

BSP Self-centering Bonded Seal

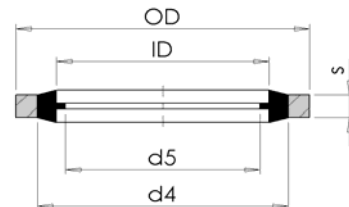

part number	Dimension					Thread
	ID	OD	d4	d5	s	
RBGA-02	10,37	15,88	11,84	8,26	2,00	1/8
RBGA-04	13,74	20,57	15,21	11,18	2,00	1/4
RBGA-06	17,28	23,80	18,75	14,76	2,00	3/8
RBGA-08	21,54	28,58	23,01	18,24	2,47	1/2
RBGA-10	23,49	31,75	24,97	20,27	2,47	5/8
RBGA-12	27,05	34,93	28,53	23,83	2,47	3/4
RBGA-14	30,81	38,10	32,29	27,51	2,47	7/8
RBGA-16	33,89	42,80	36,88	29,92	3,40	1
RBGA-20	42,93	52,38	45,93	38,45	3,40	1.1/4
RBGA-24	48,44	58,60	51,39	44,45	3,40	1.1/2
RBGA-28	54,89	69,85	58,30	50,42	3,40	1.3/4
RBGA-32	60,58	73,03	63,63	56,26	3,40	2
RBGA-40	76,08	90,17	79,38	71,50	3,40	2.1/2

## Guarnizione elastomerica per Maschio BSP/Metrico (DIN 3852 Form E)

Elastomeric seal for Metric/BSP Male (DIN 3852 Form E)

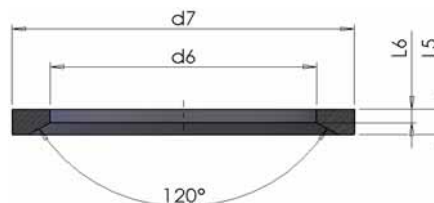
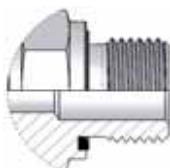

according to: DIN 3869

Codice	Size	d6	d7	L5	L6	filettatura	
						Metrica	BSP
8-E10	10	8,4	11,9	1	0,5	M10x1	1/8"-28
8-E12	12	9,8	14,4	1,5	0,8	M12x1,5	-
8-E14	14	11,6	16,5	1,5	0,8	M14x1,5	1/4-19
8-E16	16	13,8	18,9	1,5	0,8	M16x1,5	-
8-E17	17	14,7	18,9	1,5	0,8	-	3/8-19
8-E18	18	15,7	20,9	1,5	0,8	M18x1,5	-
8-E20	20	17,8	22,9	1,5	0,8	M20x1,5	-
8-E21	21	18,5	23,9	1,5	0,8	-	1/2-14
8-E22	22	19,6	24,3	1,5	0,8	M22x1,5	-
8-E27	27	23,9	29,2	1,5	0,8	M26x1,5	3/4-14
						M27x2	
8-E33	33	29,7	35,7	2	1	M33x2	1-11
8-E42	42	38,8	45,8	2	1	M42x2	1.1/4-11
8-E48	48	44,7	50,7	2	1	M48x2	1.1/2-11

## O-Ring per Maschio Metrico (ISO 6149)

O-Ring for Metric Male (ISO 6149)



according to: ISO 6149

Codice	rif. USA	rif. INGLESE	d1 - Ø int.	d2 - corda	filettatura	
					Metrica	dash
8-8.1X1.6			8,1	1,6	M10x1	10
8-9.3X2.2			9,3	2,2	M12x1,5	12
8-11.3X2.2			11,3	2,2	M14x1,5	14
8-13.3X2.2			13,3	2,2	M16x1,5	16
8-15.3X2.2			15,3	2,2	M18x1,5	18
8-19.3X2.2			19,3	2,2	M22x1,5	22
8-23.6X2.9			23,6	2,9	M27x2	27
8-29.6X2.9			29,6	2,9	M33x2	33
8-38.6X2.9			38,6	2,9	M42x2	42
8-44.6X2.9			44,6	2,9	M48x2	48

## O-Ring per Maschio ORFS

O-Ring for ORFS Male

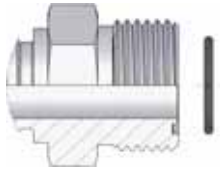

according to: SAE J515

Codice	rif. USA	rif. INGLESE	d1 - Ø int.	d2 - corda	filettatura	
					UNF	dash
8-107	2-11	2031	7,66	1,78	9/16x18	06
8-110	2-12	2037	9,25	1,78	11/16x16	09
8-2050	2-14	2050	12,42	1,78	13/16x16	11
8-2062	2-16	2062	15,6	1,78	1x14	13
8-2075	2-18	2075	18,77	1,78	1-3/16x12	14
8-2093	2-21	2093	23,52	1,78	1-7/16x12	15
8-2118	2-25	2118	29,87	1,78	1-11/16x12	21
8-2150	2-29	2150	37,82	1,78	2x12	32

## O-Ring per ogiva BSPP

O-Ring for BSPP cone

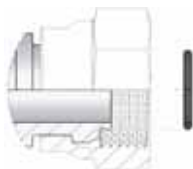

Codice	rif. USA	rif. INGLESE	d1 - Ø int.	d2 - corda	Filetto BSPP	
					Pollici	dash
8-5.5x1			5,5	1	1/4-19	04
8-7.1x1.6			7,1	1,6	3/8-19	06
8-11.1x1.6			11,1	1,6	1/2-14	08
8-2056	2-15	2056	14	1,78	5/8-14	10
8-15.1x1.6			15,1	1,6	3/4-14	12
8-2087	2-20	2087	21,95	1,78	1-11	16
8-2112	2-24	2112	28,3	1,78	1.1/4-11	20
8-2118	2-25	2118	29,87	1,78	1.1/2-11	24
8-2-32	2-32	2187	47,37	1,78	2-11	32



## O-Ring per ogiva Metrica 24°

O-Ring for Metric 24°

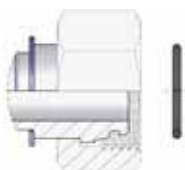

Codice	rif. USA	rif. INGLESE	d1 Ø int.	d2 corda	DKOL	DKOS	tube
8-4x1.5			4	1,5	M12x1,5	M14x1,5	6
8-6x1.5			6	1,5	M14x1,5	M16x1,5	8
8-7.5x1.5			7,5	1,5	M16x1,5	M18x1,5	10
8-9x1.5			9	1,5	M18x1,5	M20x1,5	12
8-10x2			10	2		M22x1,5	14
8-12x2			12	2	M22x1,5	M24x1,5	15-16
8-15x2			15	2	M26x1,5		18
8-16.3x2.4			16,3	2,4		M30x2	20
8-20x2			20	2	M30x2		22
8-20.3x2.4			20,3	2,4		M36x2	25
8-26x2			26	2	M36x2		28
8-25.3x2.4			25,3	2,4		M42x2	30
8-32x2.5			32	2,5	M45x2		35
8-33.3x2.4			33,3	2,4		M52x2	38
8-38x2.5			38	2,5	M52x2		42

## O-Ring per raccordo tipo 'K' per idropulitrici

O-Ring for 'K' female

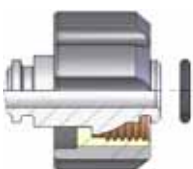

Codice	rif. USA	rif. INGLESE	d1 - Ø int.	d2 - corda	Filetto Metrico
8-10x2			10	2	M22x1,5

## O-Ring raccordo Tipo "K" (per lancia)

O-Ring for 'K' insert (for gun)

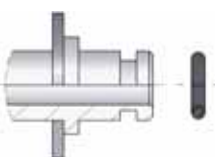

Codice	rif. USA	rif. INGLESE	d1 - Ø int.	d2 - corda	
8-105			6,07	1,78	

## O-Ring per Maschio BSP (ISO 1179-3)

O-Ring for BSP Male (ISO 1179-3)

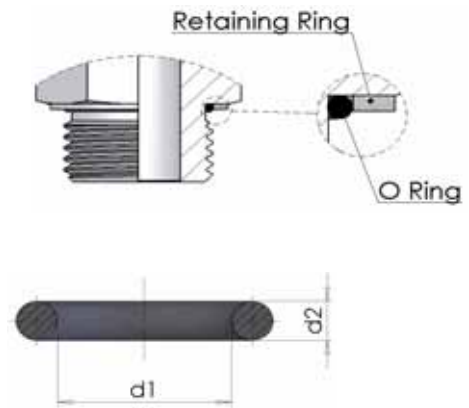

according to: ISO 1179-3

Codice	rif. USA	rif. INGLESE	d1 - Ø int.	d2 - corda	Filetto BSPP	
					Pollici	dash
8-8X1.88			7,97	1,88	1/8"-28	02
8-113	2-111	3043	10,78	2,62	1/4-19	04
8-118	2-113	3056	13,95	2,62	3/8-19	06
8-123	5-256	123	17,86	2,62	1/2-14	08
8-3093	2-119	3093	23,47	2,62	3/4-14	12
8-29.47X3.53			29,47	3,53	1-11	16
8-37.69X3.53	2-222	4150	37,69	3,53	1.1/4-11	20
8-4175	2-224	4175	44,04	3,53	1.1/2-11	24

## Anello di ritegno per Maschio BSP (ISO 1179-3)

Retaining Ring for BSP Male (ISO 1179-3)

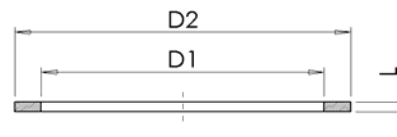

according to: ISO 1179-3

Codice	L	d1 - Ø int.	d2 - Ø est.	Filetto BSPP	
				Pollici	dash
8-R15X1.4	1,4	12,20	15,0	1/8"-28	02
8-R19.5X1.9	1,9	16,15	19,5	1/4-19	04
8-R23.5X1.9	1,9	19,50	23,5	3/8-19	06
8-R28.5X1.9	1,9	23,30	28,5	1/2-14	08
8-R34.5X1.9	1,9	28,60	34,5	3/4-14	12
8-R43.5X2.6	2,6	36,60	43,5	1-11	16
8-R52.5X2.6	2,6	44,90	52,5	1.1/4-11	20
8-R60X2.6	2,6	50,90	60,0	1.1/2-11	24

## O-Ring per Maschio Metrico

O-Ring for Metric Male

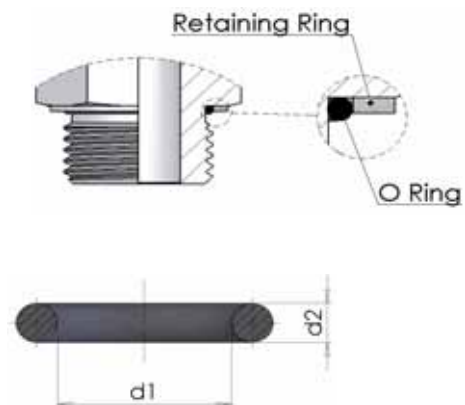

Codice	rif. USA	rif. INGLESE	d1 - Ø int.	d2 - corda	Filetto Metrico	
					Pollici	dash
8-8X1.8			8	1,8	M10x1	10
8-9.3X2.2			9,3	2,2	M12x1,5	12
8-11.3X2.2			11,3	2,2	M14x1,5	14
8-13.3X2.2			13,3	2,2	M16x1,5	16
8-3062			15,54	2,62	M18x1,5	18
8-19X2.65			19	2,65	M22x1,5	22
8-23.47X2.95			23,47	2,95	M27x2	27
8-29.4X3.1			29,4	3,1	M33x2	33
8-38X3.5			38	3,5	M42x2	42
8-4175			44,04	3,53	M48x2	48

## Anello di ritegno per Maschio Metrico

Retaining Ring for Metric Male

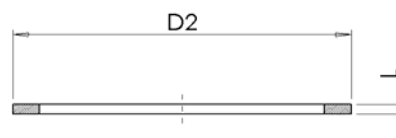

Codice	L	d2 - Ø est.	Filetto Metrico	
			Pollici	dash
8-R14.8X1	1	14,8	M10x1	10
8-R17.8X1.3	1,3	17,8	M12x1,5	12
8-R19.8X1.3	1,3	19,8	M14x1,5	14
8-R21.8X1.5	1,5	21,8	M16x1,5	16
8-R23.8X2	2	23,8	M18x1,5	18
8-R27.8X1.3	1,3	27,8	M22x1,5	22
8-R32.8X2	2	32,8	M27x2	27
8-R39.8X2	2	39,8	M33x2	33
8-R49.8X2	2	49,8	M42x2	42
8-R55.8X2	2	55,8	M48x2	48

## O-Ring per Maschio SAE (ISO 11926)

O-Ring for SAE Male (ISO 11926)

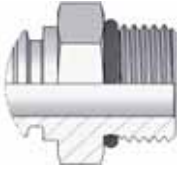

according to: ISO 11926 - SAE J515

Codice	rif. USA	rif. INGLESE	d1 - Ø int.	d2 - corda	filettatura	
					UNF	dash
8-8.92x1.83			8,92	1,83	7/16x20	04
8-10.52x1.83			10,52	1,83	1/2x20	05
8-11.89x1.98			11,89	1,98	9/16x18	06
8-16.36x2.21			16,36	2,21	3/4x16	08
8-19.18x2.46			19,18	2,46	7/8x14	10
8-23.47x2.95			23,47	2,95	1-1/16x12	12
8-29.74x2.95			29,74	2,95	1-5/16x12	16
8-37.47x3			37,47	3	1-5/8x12	20

## O-Ring per Flangia SAE J 518 (3000 PSI e 6000 PSI)

O-Ring for SAE J 518 Flange (3000 PSI and 6000 PSI)

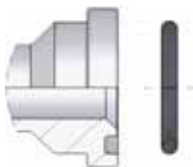

according to: SAE J515

Codice	rif. USA	rif. INGLESE	d1 - Ø int.	d2 - corda	Flangia	
					Pollici	dash
8-4075	2-210	4075	18,64	3,53	1/2	08
8-4100	2-214	4100	24,99	3,53	3/4	12
8-4131	2-219	4131	32,92	3,53	1	16
8-37.69x3.53	2-222	4150	37,69	3,53	1-1/4	20
8-4187	2-225	4187	47,22	3,53	1-1/2	24
8-4225	2-228	4225	56,74	3,53	2	32
8-4275	2-232	4275	69,44	3,53	2-1/2	40
8-4337	2-237	4337	85,32	3,53	3	48
8-4387	2-241	4387	98,02	3,53	3-1/2	56
8-4437	2-245	4437	110,72	3,53	4	64

## GPP0 **Guarnizione in poliuretano per flangie SAE J 518 (3000 PSI e 6000 PSI) e Flange Supercat**

Polyurethane seal for SAE J 518 flange (3000 PSI and 6000 PSI) and 'Cat' flanges

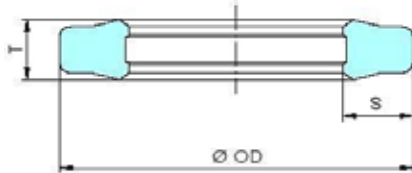

### Caratteristiche:

- Materiale standard: Poliuretano PU41 - BLU - 93 shore A
- Temperature massima di impiego: - 30°C + 100°C
- Pressione massima esercizio 610 bar
- Buona resistenza all'abrasione
- Ottima resistenza all'estrusione
- Un basso set si compressione
- Il suo profilo offre un'ottima funzione sigillante
- Utilizzabile su superfici ruvide

### Features:

- Standard material: Pu41 - Blue polyurethane 93 shore A
- Max temperature: - 30°C + 100°C
- Max working pressure 610 bar
- Good abrasion resistance
- Very high resistance to extrusion
- Low compression set
- The sealing edge offers a very good sealing functions
- Usable for rough surface finish

### Dimensioni / Dimension

Codice. Part number.		Dimensioni Dimension			
		size	OD	S	T
GPP0-08		1/2"	25,5	3,8	3,4
GPP0-12		3/4"	31,8	3,8	3,4
GPP0-16		1"	39,6	3,8	3,4
GPP0-20		1"1/4	44,5	3,8	3,4
GPP0-24		1"1/2	53,8	3,8	3,4
GPP0-32		2"	63,4	3,8	3,4

### Dimensioni d'installazione SAE

Installation SAE dimension

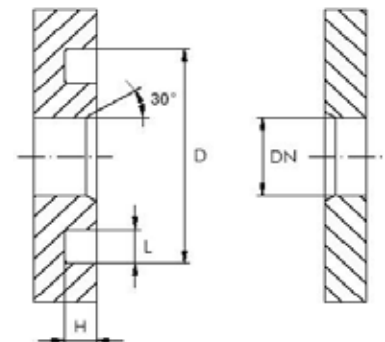

### Raccomandazioni d'installazione SAE

Installation SAE recommendations

	DN	D	H	L
size				
1/2"	13	25,40 - 25,83	2,79 - 2,92	3,94 - 4,45
3/4"	19	31,75 - 31,88	2,79 - 2,92	3,94 - 4,45
1"	25	39,62 - 39,75	2,79 - 2,92	3,94 - 4,45
1"1/4	32	44,45 - 44,58	2,79 - 2,92	3,94 - 4,45
1"1/2	38	53,72 - 53,98	2,79 - 2,92	3,94 - 4,45
2"	51	63,25 - 62,50	2,79 - 2,92	3,94 - 4,45

Le guarnizioni standard sono fornite in NBR 70. Su richiesta è possibile richiederle in NBR 90, FPM e in EPDM

*Standard seals are supplied in NBR 70. On request even in NBR 90, EPDM and FPM*

Confronto fra diverse caratteristiche degli elastomeri  
*Comparison between different features of elastomers*

Caratteristiche <i>Features</i>	Materiale / Materia		
	NBR	FPM	EPDM
Compression set <i>Compression set</i>	1	1	3
Resistenza alla lacerazione <i>Resistance to tearing</i>	2	2	3
Resistenza all'abrasione <i>Resistance to abrasion</i>	2	2-3	2
Resistenza all'invecchiamento <i>Resistance to ageing</i>	4	1	2
Resistenza all'ozono <i>Ozone resistance</i>	4	1	2
Resistenza all'olio e al grasso <i>Resistance to oil and greasy</i>	2	1	5
Resistenza ai combustibili <i>Resistance to combustibles</i>	4**	2**	5
Resistenza all'acqua calda (°C) <i>Resistance to hot water (°C)</i>	80**	80**	130
Resistenza al vapore (°C) <i>Resistance to steam (°C)</i>	-	-	130
Resistenza al calore materiali standard (°C) <i>Resistance to warmth standard materials (°C)</i>	100	200	130
Resistenza al calore materiali speciali (°C) <i>Resistance to warmth special materials (°C)</i>	120	-	-
Resistenza alle basse temperature materiali standard (°C) <i>Resistance to standard materials low temperature (°C)</i>	-30	-15	-45
Resistenza alle basse temperature materiali speciali (°C) <i>Resistance to special materials low temperature (°C)</i>	-50	-35	-

**legenda:**

**legend:**

1 - Ottima / 2 - buona / 3 - media / 4 - bassa / 5 - debole

\* - breve durata / \*\* - risultato migliore solo con materiali speciali

1 - Excellent / 2 - good / 3 - medium / 4 - low / 5 - weak

\* - short lenght / \*\* - best result only with special materials

## BOXG-BS-70

### Box O-ring NBR 70 shore - British standard

ASTM D-2000 SAE J200

30 Sizes = 382 PIECES



Part Numbers	Nominal Sizes			Q.ty nr.
	I/D	O/D	Section	
8-2012	2,9	6,46	1,78	20
8-102	3,68	7,24	1,78	20
8-103	4,48	8,04	1,78	20
8-2021	5,28	8,84	1,78	20
8-105	6,07	9,63	1,78	20
8-107	7,65	11,21	1,78	20
8-110	9,25	12,81	1,78	20
8-3037	9,19	14,43	2,62	13
8-113	10,77	16,01	2,62	13
8-3050	12,37	17,61	2,62	13
8-118	13,94	19,18	2,62	13
8-3062	15,54	20,78	2,62	13
8-3068	17,12	22,36	2,62	13
8-124	18,72	23,96	2,62	13
8-4075	18,64	25,7	3,53	10

Part Numbers	Nominal Sizes			Q.ty nr.
	I/D	O/D	Section	
8-4081	20,22	27,28	3,53	10
8-4087	21,82	28,88	3,53	10
8-4083	23,39	30,45	3,53	10
8-4100	24,99	32,05	3,53	10
8-4106	26,57	33,63	3,53	10
8-4112	28,17	35,23	3,53	10
8-29.74X3.53	29,74	36,8	3,53	10
8-4125	31,34	38,4	3,53	10
8-4131	32,92	39,98	3,53	10
8-4137	34,52	41,58	3,53	10
8-4143	36,09	43,15	3,53	10
8-37.69X3.53	37,69	44,75	3,53	10
8-6150	37,47	48,13	5,33	7
8-6162	40,64	51,3	5,33	7
8-6175	43,82	54,48	5,33	7

## BOXH-MS-70

### Box O-ring NBR 70 shore - Metric standard

ASTM D-2000 SAE J200

30 Sizes = 404 PIECES



Part Numbers	Nominal Sizes			Q.ty nr.
	I/D	O/D	Section	
8-3X2	3	7	2	18
8-4X2	4	8	2	18
8-5X2	5	9	2	18
8-6X2	6	10	2	18
8-7X2	7	11	2	17
8-8X2	8	12	2	17
8-10X2	10	14	2	17
8-10X2.5	10	15	2,5	14
8-11X2.5	11	16	2,5	14
8-12X2.5	12	17	2,5	14
8-14X2.5	14	19	2,5	14
8-16X2.5	16	21	2,5	14
8-17X2.5	17	22	2,5	14
8-19X2.5	19	24	2,5	14
8-19X3	19	25	3	12

Part Numbers	Nominal Sizes			Q.ty nr.
	I/D	O/D	Section	
8-20X3	20	26	3	12
8-22X3	22	28	3	12
8-24X3	24	30	3	12
8-25X3	25	31	3	12
8-27X3	27	33	3	12
8-28X3	28	34	3	12
8-30X3	30	36	3	12
8-32X3	32	38	3	12
8-33X3	33	39	3	12
8-35X3	35	41	3	12
8-36X3	36	42	3	12
8-38X3	38	44	3	12
8-38X4	38	46	4	9
8-42X4	42	49	4	9
8-45X4	45	52	4	9

## BOXBG Kit bonded autocentranti - BSP

BSP - Self-centering bonded seal kit

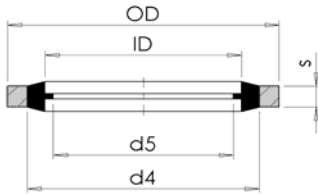

La cassetta di assortimento bonded BOXBG è composta da:

The self-centering Bonded Seal Kit BOXBG includes:

Code	Thread	Dimension					Q.ty
		ID	OD	d4	d5	s	nr.
RBGA-02	1/8	10,37	15,88	11,84	8,26	2,00	100
RBGA-04	1/4	13,74	20,57	15,21	11,18	2,00	100
RBGA-06	3/8	17,28	23,80	18,75	14,76	2,00	100
RBGA-08	1/2	21,54	28,58	23,01	18,24	2,47	100
RBGA-12	3/4	27,05	34,93	28,53	23,83	2,47	50
RBGA-16	1	33,89	42,80	36,88	29,92	3,40	50